

Life caring
design

collezione *collection*
hug

hug *life caring design* La cura di sé parte da qui.

“Molti mi chiedono le ragioni per cui abbiamo pensato di realizzare **hug**: penso che il motivo principale sia perchè mancava un luogo dove sentirsi coccolati, a proprio agio, fuori come a casa”

hug è un sistema d'arredo intelligente e sostenibile, nato dalla collaborazione dello staff tecnico Ponte Giulio con il designer DANIELE TREBBI. Il mondo **hug** sarà il punto chiave di un'esperienza emozionale da vivere con il giusto ritmo, lento e rilassante. Abbracciate questo catalogo: sarete i protagonisti di un nuovo spazio bagno di intimità e benessere.



hug is a smart and sustainable furnishing system developed by Ponte Giulio and designer DANIELE TREBBI. **hug** is the centrepiece of an emotional experience to be enjoyed at a relaxing and slow pace. Embrace this collection where you will be the protagonist of a new bathroom space of intimacy and wellbeing.

"To those who wonder what pushed us to develop **hug**, I say that there was lack of a welcoming habitat where to feel cocooned and at ease, both at home and outside"

hug *life caring design* The care of yourself begins from here

Maniglie
Grab bars
pag. 08

Contenitori
Containers
pag. 12

Lavabi
Washbasins
pag. 16

Sostegni ribaltabili
Folding grab bars
pag. 20

Piatti doccia
Shower trays
pag. 24

Sedili doccia
Shower seats
pag. 28

Sedute
Seats
pag. 32





Maniglie Grab bars



Vaschetta contenitore Bowls



Corallo
Coral red

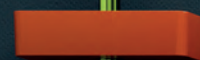

Bianco canapa
Hemp white



Grafite
Graphite



Mensola Shelf

Bianco alpino
Alpine white

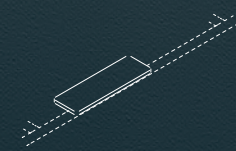

100
Kg



Maniglie Grab bars

Montaggio in orizzontale o verticale
Horizontal or vertical mounting



38,6 cm
48,6 cm
58,6 cm
68,6 cm
90,6 cm
100 cm

175,6 cm

175 cm

Colori standard Standard colours

Melanzana
Aubergine



Rame
Copper



Lime
Lime



Punti rossi
Red dotted



Punti neri
Black dotted



Lucido
Bright



Satinato
Satin



Bianco canapa
Hemp white



Colori speciali su richiesta Special colours on demand

Nichel nero
Black nickel

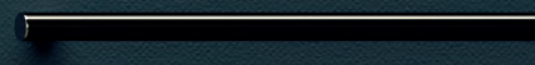

Nichel nero satinato
Satin black nickel



Bronzo scuro satinato
Dark satin bronze



Nichel bronzo satinato
Satin bronze nickel

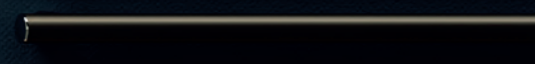

Oro rosa
Pink gold



Oro rosa satinato
Satin pink gold



Oro satinato
Satin gold







La maniglia accessoria sui mobili è un utile aiuto per alzarsi
The grab bar integrated in the cabinet is handy to stand up

Montaggio su barra
Mounted on grab bars

20x10x170 cm

Con specchio
With mirror



retro mobile con mensole
back with shelves

20x17x170 cm

A giorno
Open shelves



Colori/finiture maniglie
Colours/grab bars finishes



Melanzana
Aubergine



Lucido
Bright



Rame
Copper



Satinato
Satin



Lime
Lime



Bianco
White



Montaggio a parete
Wall mounted

20x17x117 cm

A giorno
Open shelves



Colori contenitori
Containers colours

Cartazucchero
Mid blue

30x17x150 cm

Con anta
With door



Seta
Silk grey

Maniglia a destra
Grab bar on the right



Bianco puro
Pure white

Maniglia a sinistra
Grab bar on the left





Lavabi e consolle *Washbasins and consoles*

Specchiere *Mirrors*

Luce LED integrata
Integrated LED lighting

68 x 75 cm
Specchio inclinabile
Tilting mirror

66 x 95 cm
100 x 95 cm
Specchio fisso
Fixed mirror

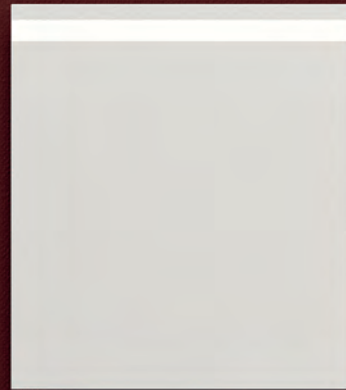

Lavabi in minerale composito *Mineral composite washbasins*

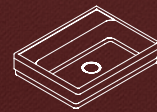

68,5 x 52 x 19 cm
Lavabo
Washbasin

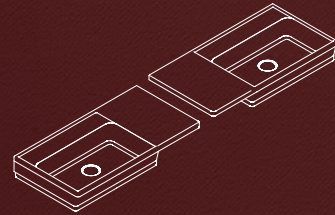

100 x 52 x 19 cm
Consolle con catino lato sx o dx
Console with left or right hand-side basin

Lavabi in pietra acrilica *Acrylic stone washbasins*

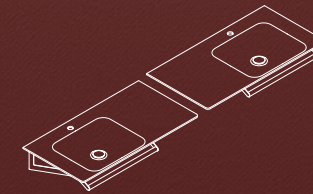

100 x 52 x 19 cm
Consolle con catino lato sx o dx
Console with left or right hand-side basin

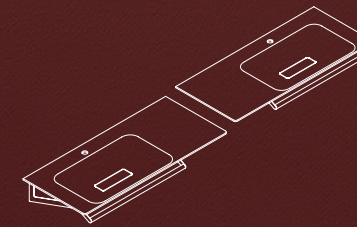

120 x 52 x 19 cm
Consolle con catino lato sx o dx
Console with left or right hand-side basin

Colori cassetti *Drawers' colours*



Bianco puro
Pure white

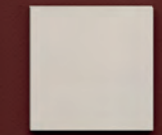

Seta
Silk grey



Cartazucchero
Mid blue



Il cassetto singolo e la cassetiera sottopiano possono essere installati su tutte le consolle della collezione, sia lato destro sia sinistro.
Both the single and double drawers for under-top installation are for right and left hand-side mounting on each console of the collection



Portasciugamani acciaio inox lucido
Disponibile versione destra o sinistra
Bright inox towel holder. Available in right and left versions



Cassetto singolo
Single drawer



Misure personalizzabili su richiesta
Customizable dimensions on demand



Portasciugamani acciaio inox lucido
Bright inox towel bar included

Cassetiera
Drawer



Sostegni Ribaltabili *Folding grab bars*

L'articolo può essere rimosso senza l'ausilio di attrezzi specifici dalla piastra fissata a muro. Al suo posto può essere inserita una semplice copri-piastra.

The product can be uninstalled from the wall flange without the use of any specific tools and can be replaced by a simple plate cover.



Accessori Accessories

Gli accessori possono essere installati sia singolarmente sia insieme.
The accessories can be mounted both individually and together.

Porta rotolo
Roll holder

Finitura cromo
Chrome finish

Poggia braccia
Armrest

Colore bianco
White colour

Colore antracite
Anthracite colour

Copri piastra Plate cover



Bianco
White

Cromo
Chrome

Antracite
Anthracite



Colori Colours





SHOTS
COUNTRY
IK

Piatto doccia in minerale composito
Mineral composite shower tray

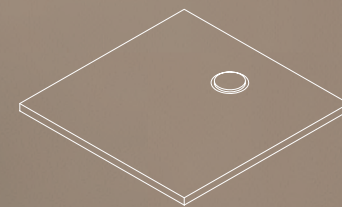

90x90 cm

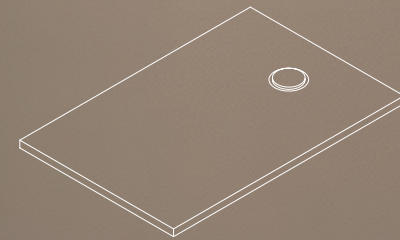

120x80 cm

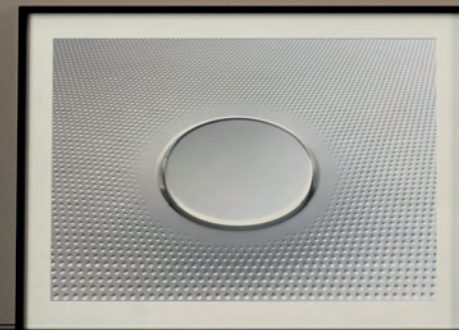

Texture antiscivolo
Non-slip texture

Piatto doccia pietra acrilica
Acrylic-stone shower tray



Piletta di scarico
filo piatto / finitura cromo
Surface-level drain
Chrome finish



Piletta di scarico
finitura cromo
Drain
Chrome finish

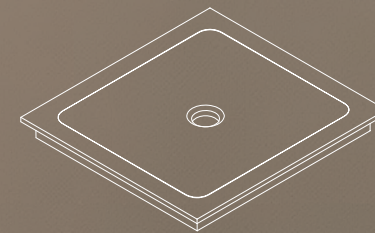

Misure personalizzabili su richiesta
Customizable dimensions on demand

Box doccia
Shower enclosures

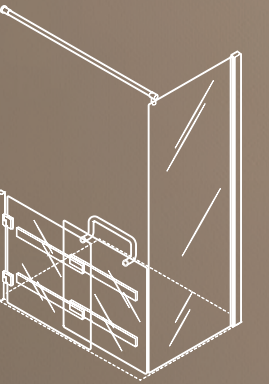

120x80x195 cm
Anta bassa scorrevole e tenda
versione destra e sinistra
Low sliding door and curtain
Right and left version

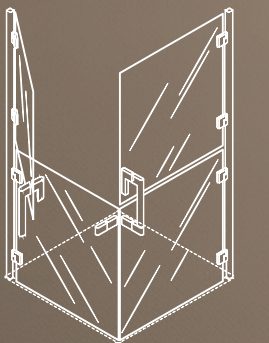

90x90x195 cm
Ante sdoppiate
Split doors

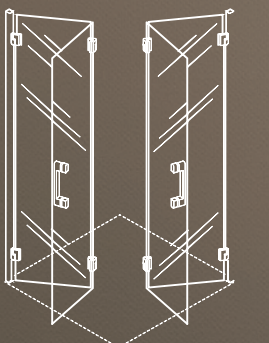

90x90x195 cm
Ante a libro
Accordion doors

(pag. 26 - 27)



Sedili doccia *Shower seats*



Sedile doccia
Shower seat



42x46x11 cm



Accessori *Accessories*

Schienale per sedile doccia
Backrest for shower seat

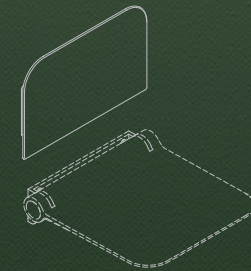

42x4x27 cm



Schienale con braccioli
per sedile doccia
*Backrest with armrests for
shower seat*

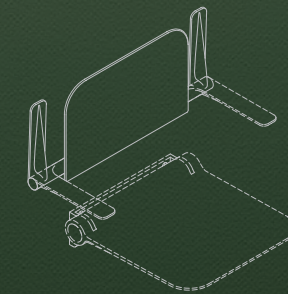

60x26x27 cm



Colori *Colours*



Bianco canapa
Hemp white



Corallo
Coral red



Grafite
Graphite



Sedute Seats

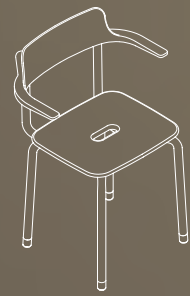

Seggiola con schienale munito di braccioli. Piedini regolabili.

Chair with backrest and armrest. Adjustable feet

42x53x73,5 cm

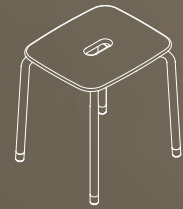

Sgabello, piedini regolabili

Stool with adjustable feet

42x35x44,5 cm

Colori seduta Seats colours



Bianco canapa
Hemp white



Corallo
Coral red



Grafite
Graphite

Colori struttura Frame colours



Melanzana
Aubergine



Rame
Copper

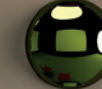

Lime
Lime



Lucido
Bright



Satinato
Satin



Bianco
White

Molteplici combinazioni di colore seduta / struttura.

Multiple colour combinations of the seating / structure.



Più colori sono disponibili su richiesta. Per l'elenco completo vedi palette maniglie a pag. 9

More colours are available on demand. For the complete list check the grab bars palette on page 9

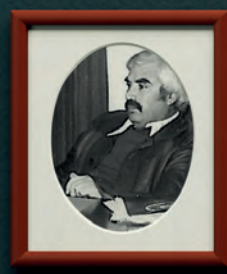
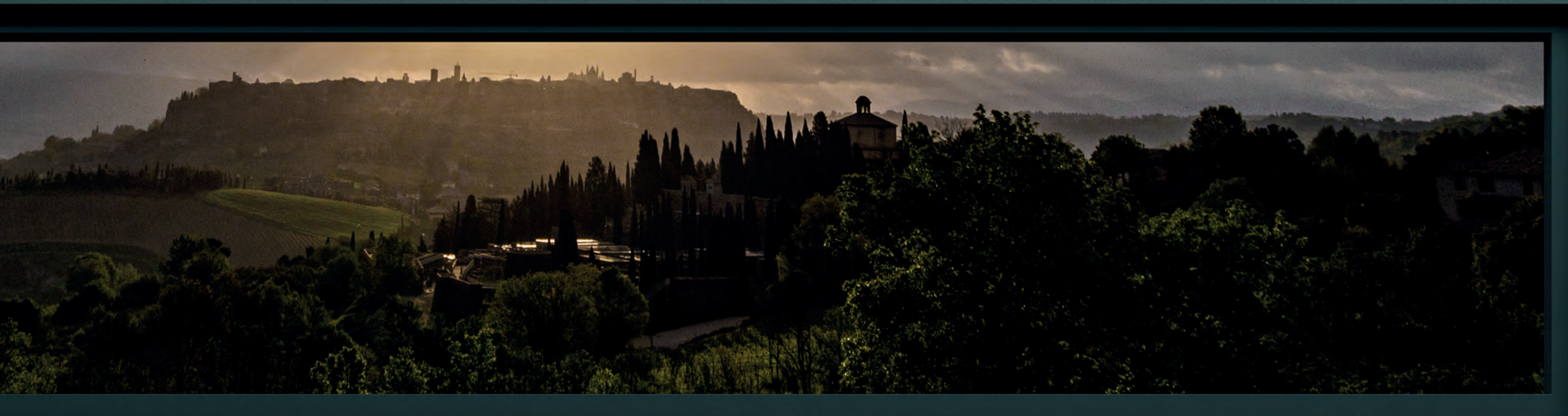

Io, il fondatore.
Emidio Carloni.

*Me, the founder.
Emidio Carloni.*



Siamo nati nel 1973 ad Orvieto e operiamo in 50 paesi del mondo. Le nostre sedi sono in Italia, Stati Uniti e Regno Unito.

We were established in 1973 and we operate in 50 countries across the world. Our offices are in Italy, USA and UK.



Integriamo tradizione, competenza, creatività, ingegneria, chimica e logistica. Elaboriamo progetti su misura e soluzioni chiavi in mano.

We integrate tradition, knowledge, creativity, engineering, chemistry and logistics. We develop custom projects and provide turn-key solutions.



Valorizziamo le risorse umane investendo nella loro formazione.

We value human resources and invest in their training.

Produciamo nel pieno rispetto dell'ambiente contenendo le emissioni in atmosfera del ciclo di manifattura e riducendo il consumo energetico e lo sfruttamento delle risorse naturali.

We respect the environment by limiting air emissions and reducing energy consumption and the use of natural resources.

Impieghiamo tecnologia a ioni di argento per garantire una protezione contro i batteri e selezioniamo le materie prime evitando l'uso di sostanze tossiche.

We use silver ion-based technology to grant protection against bacteria and we select raw materials free from toxic substances.

Guardiamo al futuro con continue innovazioni di processo e di prodotto nel pieno rispetto delle normative

We continuously innovate our processes and products in compliance with regulations

collection
hug

life caring design

È tante idee innovative destinate a prendersi cura della vita delle persone in ogni suo aspetto.

Is a wealth of ideas destined to the care for every aspect of people's life



La collezione **hug** condivide valori legati alla sfera dell'intimo e alla cura attenta di sé e degli altri. Le grandi maniglie dal design contemporaneo, elementi portanti del progetto, sono sicure e funzionali, ma anche versatili e creative: nelle loro versioni orizzontali e verticali, dialogano a colori con specchi, mobili, contenitori e lavabi.

*The **hug** collection shares values linked to the intimate side and care of oneself and the others. The grab bars from the contemporary design are in the spotlight. They are safe and functional but also extremely versatile and creative. They come in vertical and horizontal versions and match perfectly with the mirrors, furnishing elements, containers and washbasins of the project.*

Life è prendersi cura di sé e della propria famiglia sia in termini di accudimento che di sicurezza.

Associata al concetto di *Caring* si estende a tutti gli ambiti di confort, benessere e realizzazione di sé.

Design è progettazione unita al valore estetico e alla cura delle forme da cui muove il processo di attrazione e la nascita di un'esperienza emozionale.

Life is caring for yourself and your family's comfort and safety

Caring is associated to comfort, well-being and self-fulfilment

Design with aesthetics values in mind and attention to shapes able to attract and create an emotional experience.



safety design

Abitare, accogliere, assistere, ospitare: ci riconoscono un ruolo importante nell'ambito del benessere e della sicurezza nello spazio bagno privato e pubblico per tutti.

Living, welcoming, assisting, hosting... we have a key role in the well-being and safety of private and public bathroom spaces for all.

life caring design

collezione *collection*
hug

Listino Prezzi *Price List*

01

Gli elementi del sistema *The elements of the system*

P. 48
Maniglia di sicurezza verticale
Vertical grab rail

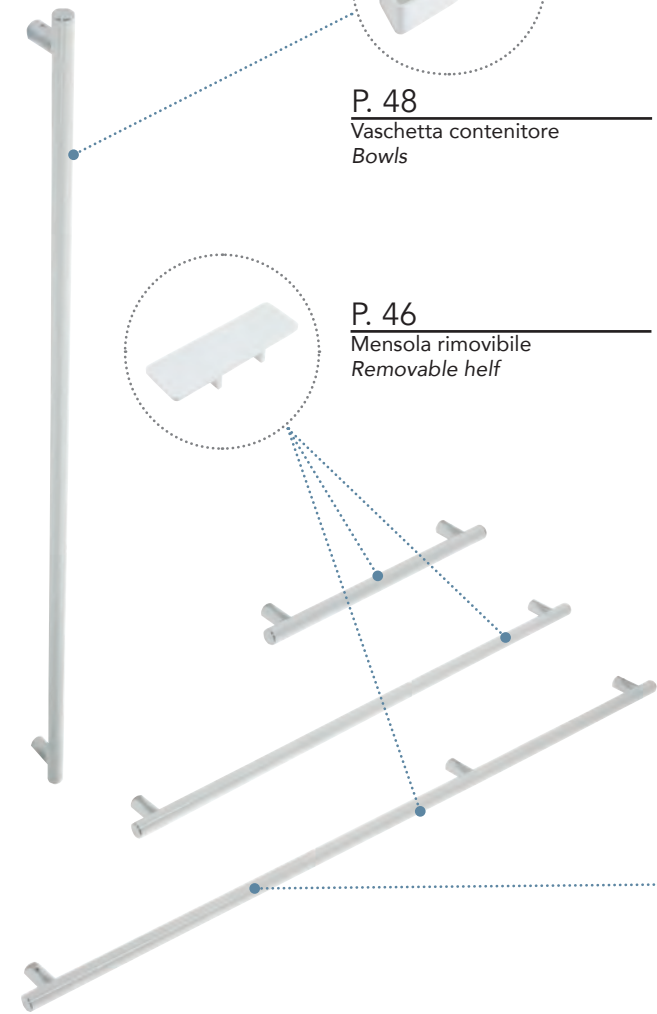

P. 48
Vaschetta contenitore
Bowls

P. 62
Appendi abito
Hook hang

P. 62
Porta rotolo
Roll paper holder

P. 46
Mensola rimovibile
Removable shelf

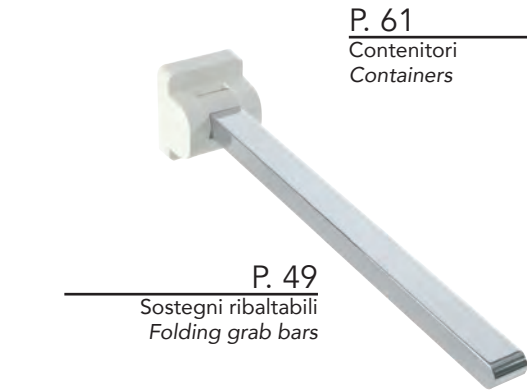

P. 49
Sostegni ribaltabili
Folding grab bars

P. 61
Contenitori
Containers

P. 61
Maniglie per contenitori
Containers handles



P. 63
Specchio inclinabile
Tilting mirror

P. 46-48
Maniglia di sicurezza
Grab rail

P. 61
Contenitori da agganciare su sostegno orizzontale
Containers to hung on horizontal grab bars

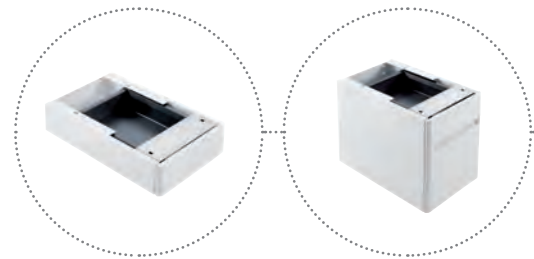

P. 53
Cassetto e cassetiera
Drawer and drawers



P. 60
Box doccia, con un pannello fisso ed uno basso scorrevole
Low sliding door, with fix panel and curtain shower enclosure



P. 59
Piatto doccia in pietra acrilica
Solid surface shower tray



P. 60
Box doccia con ante sdoppiate
Split doors shower enclosure



P. 59
Piatto doccia in minerale composito
Mineral composite shower tray



P. 60
Box doccia con ante a libro
Accordion doors shower enclosure

P. 52
Lavabo in minerale composito
Mineral composite washbasin



P. 53 / 54
Consolle in minerale composito
Mineral composite console



P. 51
Sedile ribaltabile
Folding seat



P. 55 / 58
Consolle in pietra acrilica
Solid surface console



P. 51
Sgabello
Stool



P. 51
Sedia
Seat

Articoli di complemento suggeriti
Suggested Items for matching



P. 64
Miscelatore per lavabo
Washbasin mixer



P. 64
Miscelatore per bidet
Bidet mixer



P. 64
Miscelatore ad incasso per doccia
Mixer, recessed, for shower



P. 68 / 70
Vaso sanitario e bidet
WC bowl and bidet













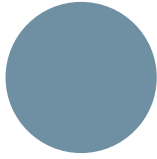

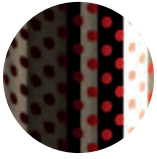

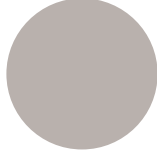





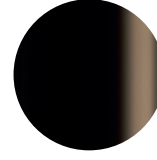

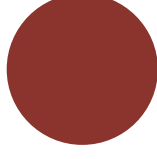

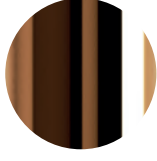
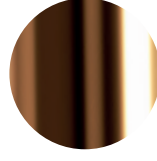

P. 66 / 67 / 69
Vaso sanitario e bidet sospesi
wall-hung WC bowl and bidet

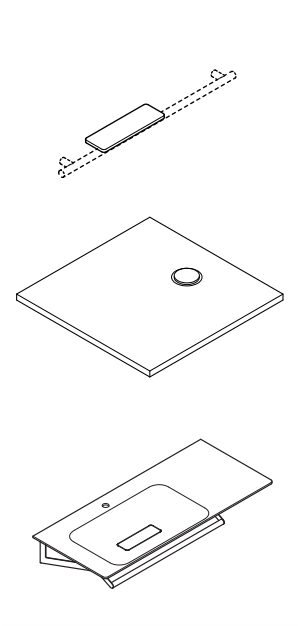
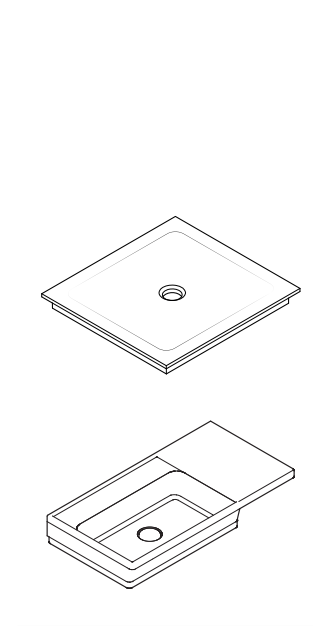
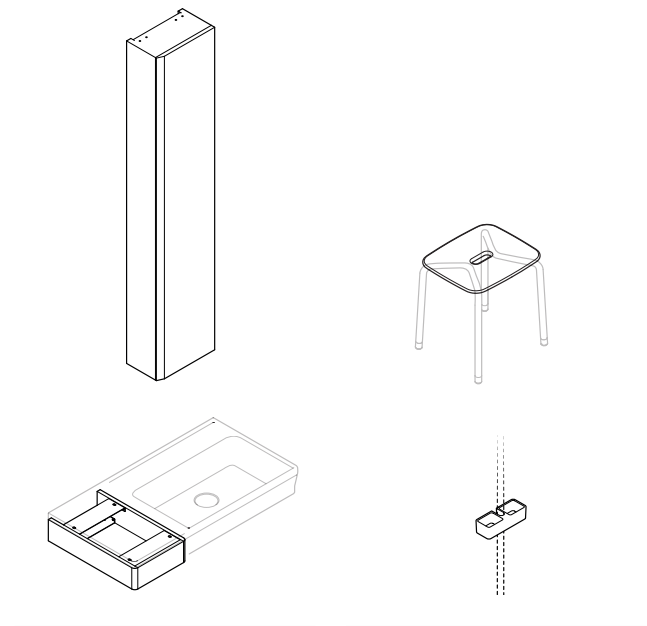
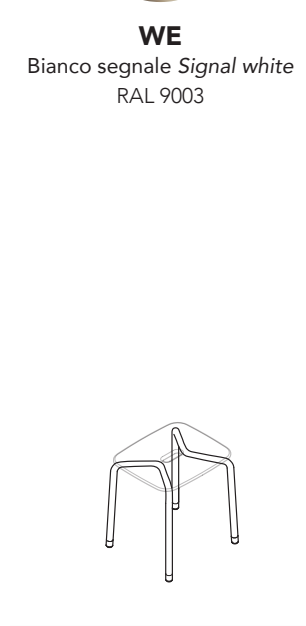

P. 65
Soffione doccia
Shower head

Tabella dei colori e delle finiture *List of colours and finishes*

Pietra acrilica <i>Solid surface</i>	Composito minerale <i>Mineral composite</i>	Smalto acrilico finitura opaca <i>Acrylic varnish opaque finish</i>	Polvere poliestere finitura lucida <i>Polyester powder shiny finish</i>	Impressione digitale finitura lucida <i>Digital imprint shiny finish</i>	Trattamenti superficiali su metallo e plastica <i>Surface treatments on metallic and plastic surfaces</i>				
 W3 Bianco alpino <i>Alpine white</i>	 WM Bianco Canapa <i>Hemp white</i>	 BZ Cartazucchero <i>Mid blue</i>	 DD Grafite <i>Graphite</i> RAL 7024	 P5 Melanzana <i>Aubergine</i>	 V3 Punti rossi <i>Red dotted</i>	 N2 Lucido <i>Bright</i> opzionali su richiesta <i>optional on demand</i> finitura lucida <i>shiny finish</i> finitura opaca <i>opaque finish</i>		
		 IB Seta <i>Silk grey</i>	 R2 Rame <i>Copper</i>	 V4 Punti neri <i>Black dotted</i>	 C1 Cromo <i>Chrome</i>	 E1 Nickel nero <i>Black nichel</i>	 E3 Oro satinato <i>Satin gold</i>	 E6 Bronzo scuro satinato <i>Dark satin bronze</i>	
		 WD Bianco puro <i>Pure white</i>	 WE Bianco segnale <i>Signal white</i> RAL 9003	 G9 Lime <i>Lime</i>	<p>Applicabile solo su barre con una lunghezza massima di 900 mm. <i>Applicable only on bars with a maximum length of 900 mm.</i></p>	 E2 Oro rosa <i>Pink gold</i>	 E4 Oro rosa satinato <i>Satin pink gold</i>	 E7 Nickel bronzo satinato <i>Satin bronze nichel</i>	
		 PB Corallo <i>Coral red</i> RAL 3016	 WE Bianco segnale <i>Signal white</i> RAL 9003	<p>Applicabile solo su barre con una lunghezza massima di 900 mm. <i>Applicable only on bars with a maximum length of 900 mm.</i></p>	 E5 Nickel nero satinato <i>Satin black nichel</i>				
									
Consolle, piatti doccia ed accessori <i>Console, shower tray and accessories</i>	Consolle e piatti doccia <i>Console and shower trays</i>	Mobili <i>Furniture</i>	Sedute e accessori <i>Seats and accessories</i>	Maniglioni, maniglie e strutture di sgabelli e sedie <i>Grab bars, handles and stool/seat structure</i>					

I colori qui riprodotti hanno lo scopo di mera indicazione, per riscontro su colori reali si suggerisce di chiedere a Ponte Giulio i campioni colore

Above printed colours have to be considered as a mere guide, for the real colours please ask Ponte Giulio the colour sample.

Elenco materiali *List of materials*

PU Poliuretano Polyurethane	<p>Con il termine poliuretano - PU - si indica una vasta famiglia di polimeri; il poliuretano rigido compatto è un tecnopolimero ottenuto per reazione chimica tra due componenti base: poliolo e isocianato. Questo materiale sintetico può essere prodotto in un'ampia gamma di densità permettendone l'utilizzo nelle applicazioni più diverse, garantendo elevate prestazioni meccaniche e termiche.</p> <p>Particolarmente idoneo per componentistica di dimensioni medio grandi il poliuretano rigido consente di ottenere superfici esterne resistenti, elevata precisione dimensionale, stabilità alle variazioni di temperatura e durata nel tempo.</p>	<p>Polyurethane - PU - belongs the family of polymers. Compact rigid polyurethane is a technopolymer obtained through a chemical reaction between two basic components, polyol and isocyanate. This synthetic material can be produced in different densities for use in several applications. It grants high mechanical and thermal performance.</p> <p>Polyurethane is particularly suitable to manufacture components of medium to large size. Rigid polyurethane creates resistant external surfaces and provides high dimensional precision, durability and thermal stability.</p>
AI Acciaio inossidabile Stainless steel	<p>Gli acciai inossidabili sono leghe di ferro caratterizzate, oltre che dalle proprietà meccaniche tipiche degli acciai al carbonio, da una notevole resistenza alla corrosione, specie in aria umida o in acqua dolce. Tale capacità di resistere alla corrosione è dovuta alla presenza di elementi di lega, principalmente il cromo, in grado di passivarsi, cioè ricoprirsi di uno strato di ossidi, sottile ed aderente, praticamente invisibile, che protegge il metallo, o la lega, sottostante dall'azione degli agenti chimici esterni.</p>	<p>Stainless steel is an iron alloy which offers the mechanical properties of carbon steel. It also provides resistance to corrosion especially when used in damp environments or with fresh water. This is thanks to the presence of alloy elements, particularly chromium, which passivate the surface by layering it with practically invisible, thin and adherent oxides that protect the metal beneath from the action of external chemical agents.</p>
FM Fibra media densità Medium density fibreboard	<p>Il "Medium-density fibreboard" è un derivato del legno, il più noto e diffuso tra le diverse proposte di pannelli in fibra. Viene distinto in base al processo impiegato e alla densità in: bassa (LDF), media (MDF) e alta (HDF).</p> <p>I pannelli in fibra a media densità sono ideali per la realizzazione di arredamenti laccati opachi, satinati, semilucidi e lucidi in quanto privi di ondulazioni che possano comprometterne il risultato finale del manufatto.</p>	<p>Medium density fibreboard is a derivate of wood and the most known and popular amongst fibre boards. It can have low (LDF), medium (MDF) or high (HDF) density. Medium density fibreboards have a smooth surface, hence ideal for the production of opaque lacquered, satin, semi-polished and polished furniture elements.</p>
PA Pietra acrilica Acrylic stone	<p>La pietra acrilica è un materiale sviluppato e prodotto dalla DuPont dal 1967 e commercializzato con il nome "Corian". Questo materiale sintetico, unisce i pregi dei materiali naturali, come la pietra, al vantaggio di essere prodotto in qualsiasi forma e lavorabile come il legno.</p> <p>Si tratta di un materiale composito formato da 2/3 di idrossido di alluminio e 1/3 di resina acrilica con eventuale aggiunta di pigmenti colorati.</p> <p>Grazie alle caratteristiche uniche questo materiale ha un larghissimo impiego specialmente in architettura, nell'arredamento e nell'oggettistica di pregio.</p>	<p>Acrylic stone is a material developed and produced by DuPont since 1967 and traded under the name "Corian". This synthetic material blends the features of natural elements such as stone, with the advantage of being manufactured in any shape and ability of being easily processed like wood. It is a composite material formed by 2/3 of aluminium hydroxide and 1/3 acrylic resin with potential addition of coloured pigments.</p> <p>Acrylic stone is widely used in architecture, furnishing and high-end goods production thanks to its unique features..</p>
CM Composito minerale Mineral composite	<p>Materiale sintetico il cui componente principale è la pietra dolomitica impiegata in una quantità non inferiore al 75%. Questo minerale, in varie dimensioni, unito alla resina, forma una base con proprietà fisico/chimiche impareggiabili. Lo strato esterno è realizzato con un nanorivestimento, di resina polimerizzata, miscelata omogeneamente con particelle di pigmento e di quarzo, che conferisce la finitura finale e la levigatezza della superficie del prodotto.</p> <p>Tutti i componenti del Mineral Composite sono ecologici.</p>	<p>It is a synthetic material formed by at least 75% of stone from the Dolomites. It comes in various dimensions and is mixed with resin providing unparalleled physical and chemical properties.</p> <p>Externally it is covered by a nano layer of polymerised resin which is mixed homogeneously with pigment particles and quartz that grant a smooth surface. Mineral Composite is an ecological material.</p>
AL Alluminio Aluminium	<p>L'alluminio è un metallo duttile color argento, disponibile in natura estratto dai minerali di bauxite. Tra le sue caratteristiche si ricordano la notevole morbidezza, la leggerezza e la resistenza all'ossidazione, dovuta alla formazione di un sottilissimo strato di ossido che impedisce all'ossigeno di corrodere il metallo sottostante.</p> <p>L'alluminio grezzo viene lavorato tramite diversi processi di produzione industriale, quali ad esempio la fusione, l'estrusione, la forgiatura o lo stampaggio.</p> <p>Questo metallo trova ampia utilizzazione in molti ambiti industriali, dall'alimentare, all'elettronica, le costruzioni fino all'aerospaziale.</p>	<p>It is a ductile material with a silver colour. It is extracted from bauxite minerals. It is extremely soft, light, and resistant to oxidation thanks to a thin layer of oxide on the surface which prevents the oxygen from corroding the metal beneath.</p> <p>Unrefined aluminium is industrially processed through fusion, extrusion, forge and pressing. This metal is widely used in various industrial fields such as food, electronics, engineering and aerospace.</p>

AB ABS ABS	<p>L'acrilonitrile-butadiene-stirene o ABS, è un comune polimero termoplastico utilizzato per creare i più svariati oggetti. L'ABS ha un largo impiego proprio per le caratteristiche di resistenza meccanica, e stabilità fisica, inoltre trova grande applicazione nella realizzazione di prodotti mediante l'utilizzo di macchine di prototipazione rapida che utilizzano tecniche produttive quali la FDM (Fused Deposition Modeling).</p>	<p>Acrylonitrile butadiene styrene or ABS is a common thermoplastic polymer used to create a vast range of goods. It is widely used for its mechanical resistance and physical stability. It is commonly adopted to manufacture products by rapid prototyping machines that use production techniques such as FDM (Fused Deposition Modelling).</p>
AC Acciaio Steel	<p>Acciaio è il nome dato a una lega composta principalmente da ferro e carbonio, quest'ultimo in percentuale non superiore al 1,7%: oltre tale limite, le proprietà del materiale cambiano e la lega assume la denominazione di ghisa.</p> <p>Il "ferro" nome con cui comunemente viene chiamato l'acciaio fa parte della storia dell'uomo avendo avuto, e continuando ad avere, larghissimo impiego in praticamente ogni ambito industriale.</p>	<p>It is an alloy composed mainly by steel and up to 1.7% of carbon. In case of a higher carbon percentage the material's properties change and the alloy becomes cast iron. Steel is commonly referred to as "Iron". It has been used for centuries and keeps on being widely adopted industrially.</p>
PS Porcellana sanitaria Sanitary porcelain	<p>La porcellana "feldspatica" o porcellana dura è un composto in cui sono presenti feldspato, da cui il nome, caolino e quarzo; talvolta viene aggiunta argilla. Una volta sottoposto a cottura - con temperature che variano tra i 1000° e i 1500° - acquisisce particolari caratteristiche come resistenza al calore, ai graffi, gli urti e agli agenti chimici.</p> <p>In ragione della composizione si possono ottenere manufatti estremamente diversi, che variano dalle porcellane raffinatissime agli isolatori per alta tensione.</p>	<p>Hard porcelain is a mixture of feldspar, kaolin and quartz with sometimes the addition of clay. It undergoes a firing process with temperatures between 1000°C and 1500°C where it acquires features such as resistance to heat, scratches, impacts and chemical agents.</p> <p>Many different products can be manufactured with this material, from refined ceramics to high voltage insulators.</p>
CV Vetro Glass	<p>Il vetro viene ottenuto dal processo di fusione ad alta temperatura, e dal successivo raffreddamento, di una miscela di silicati. Il materiale così ottenuto serve per fabbricare finestre, bicchieri, vasi, lampadari e molti altri oggetti; la maggior parte degli utilizzi del vetro derivano dalla sua trasparenza, dalla sua inalterabilità chimica e dalla sua versatilità. Grazie all'aggiunta di determinati elementi, è possibile creare vetri con differenti colorazioni e proprietà chimico-fisiche.</p> <p>Il vetro può essere fuso nuovamente e riutilizzato quasi infinite volte.</p>	<p>Glass is obtained through high temperature fusion and the subsequent cooling of a mixture of silicates. This material is used to manufacture windows, glasses, vases, lamps and many other objects. Glass is widely used for being transparent, chemically stable and extremely versatile.</p> <p>Glass can be made in different colours and gains chemical and physical properties by adding specific elements. Glass can be fused again and used countless times.</p>
PE Polietilene Polyethylene	<p>Il polietilene è il più semplice dei polimeri sintetici ed è la più comune fra le materie plastiche, si presenta come un solido trasparente con ottime proprietà isolanti e di stabilità chimica, è un materiale molto versatile tanto da essere impiegato in molti contesti, dall'agricoltura, alla cosmetica, dall'alimentare agli imballaggi.</p>	<p>Polyethylene is the simplest of synthetic polymers and is the most common among plastics, is a transparent solid with excellent insulating properties and chemical stability, is a very versatile material so as to be used in many contexts, from agriculture, to cosmetics, from food to packaging.</p>
RU Resine ureiche Urea resins	<p>Con "résine urèiche" si identificano materie plastiche termoindurenti derivate dalla policondensazione di urea e formaldeide, appartenenti al gruppo delle resine amminiche. Di facile lavorabilità, sono utilizzate per la realizzazione di elettrodomestici, nell'abbigliamento, per oggetti di arredamento, per gli impianti igienici, come leganti nell'industria del legno, come vernici e colle.</p>	<p>Urea resin identify thermosetting plastics deriving from the polycondensation of urea and formaldehyde, belonging to the group of amino resins. Easy to work with, they are used for the manufacture of household appliances, clothing, furnishing objects, hygienic systems, as binders in the wood industry, such as paints and glues.</p>

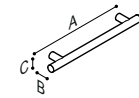

[AxBxC] 386x82x32 mm.

Maniglia di sicurezza, 38,6 cm.
Grab rail, 38,6 cm.

colori colours

G9 R2 P5 WE N2

V4 V3

G18UAS32 XX

€ 82,00 N2

€ 93,00 G9; P5; R2; WE

€ 206,00 V4; V3

Carico Load ↓↘ 120 kg.

Peso Weight 0,60 kg.

Materiali Materials AI AL AB

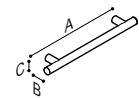

[AxBxC] 486x82x32 mm.

Maniglia di sicurezza, 48,6 cm.
Grab rail, 48,6 cm.

colori colours

G9 R2 P5 WE N2

V4 V3

G18UAS33 XX

€ 84,00 N2

€ 97,00 G9; P5; R2; WE

€ 210,00 V4; V3

Carico Load ↓↘ 120 kg.

Peso Weight 0,75 kg.

Materiali Materials AI AL AB

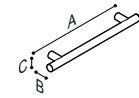

[AxBxC] 586x82x32 mm.

Maniglia di sicurezza, 58,6 cm.
Grab rail, 58,6 cm.

colori colours

G9 R2 P5 WE N2

V4 V3

G18UAS34 XX

€ 88,00 N2

€ 101,00 G9; P5; R2; WE

€ 215,00 V4; V3

Carico Load ↓↘ 120 kg.

Peso Weight 0,90 kg.

Materiali Materials AI AL AB



Mensola per installazione su maniglia orizzontale [LxPxA] 270x95x42 mm.
Shelf for horizontal handle installation [WxDxH] 270x95x42 mm.

Colori colours

W3

Materiali Materials PA

F47ANM10

€ 75,00

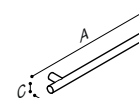

[AxBxC] 686x82x32 mm.

Maniglia di sicurezza, 68,6 cm.
Grab rail, 68,6 cm.

colori colours

G9 R2 P5 WE N2

V4 V3

G18UAS35 XX

€ 91,00 N2

€ 104,00 G9; P5; R2; WE

€ 216,00 V4; V3

Carico Load ↓↘ 120 kg.

Peso Weight 1,05 kg.

Materiali Materials AI AL AB



Mensola per installazione su maniglia orizzontale [LxPxA] 270x95x42 mm.
Shelf for horizontal handle installation [WxDxH] 270x95x42 mm.

Colori colours

W3

Materiali Materials PA

F47ANM10

€ 75,00

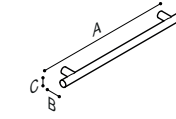

[AxBxC] 906x82x32 mm.

Maniglia di sicurezza, 90,6 cm.
Grab rail, 90,6 cm.

colori colours

G9 R2 P5 WE N2

V4 V3

G18UAS37 XX

€ 94,00 N2

€ 113,00 G9; P5; R2; WE

€ 224,00 V4; V3

Carico Load ↓↘ 120 kg.

Peso Weight 1,2 kg.

Materiali Materials AI AL AB



Mensola per installazione su maniglia orizzontale [LxPxA] 270x95x42 mm.
Shelf for horizontal handle installation [WxDxH] 270x95x42 mm.

Colori colours

W3

Materiali Materials PA

F47ANM10

€ 75,00

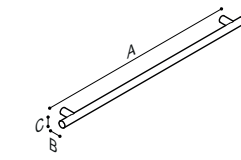

[AxBxC] 1006x82x32 mm.

Maniglia di sicurezza, 100,6 cm.
Grab rail, 100,6 cm.

colori colours

G9 R2 P5 WE N2

G18UAS38 XX

€ 102,00 N2

€ 116,00 G9; P5; R2; WE

Carico Load ↓↘ 120 kg.

Peso Weight 1,3 kg.

Materiali Materials AI AL AB



Mensola per installazione su maniglia orizzontale [LxPxA] 270x95x42 mm.
Shelf for horizontal handle installation [WxDxH] 270x95x42 mm.

Colori colours

W3

Materiali Materials PA

F47ANM10

€ 75,00

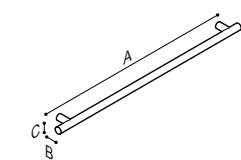

[AxBxC] 1306x82x32 mm.

Maniglia di sicurezza, 130,6 cm.
Grab rail, 130,6 cm.

colori colours

G9 R2 P5 WE N2

G18UAS39 XX

€ 110,00 N2

€ 127,00 G9; P5; R2; WE

Carico Load ↓↘ 120 kg.

Peso Weight 1,5 kg.

Materiali Materials AI AL AB



Mensola per installazione su maniglia orizzontale [LxPxA] 270x95x42 mm.
Shelf for horizontal handle installation [WxDxH] 270x95x42 mm.

Colori colours

W3

Materiali Materials PA

F47ANM10

€ 75,00

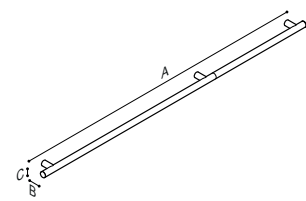

[AxBxC] 1750x82x32 mm.

Maniglia di sicurezza, munita di tre ancoraggi a muro. Adatta per sostenere mobili da appoggio, 175 cm.

Grab rail, equipped with three wall anchors. Suitable for supporting furniture, 175 cm.

colori colours
G9 R2 P5 WE N2

G18UAS40 XX

€ 158,00 N2

€ 179,00 G9; P5; R2; WE

Carico Load ↓↘ 120 kg.

Peso Weight 2,3 kg.

Materiali Materials AI AL AB



Mensola per installazione su maniglia orizzontale [LxPxA] 270x95x42 mm.

Shelf for horizontal handle installation [WxDxH] 270x95x42 mm.

Colori colours

W3

Materiali Materials

PA

F47ANM10

€ 75,00



[AxBxC] 32x82x1750 mm.

Maniglia di sicurezza verticale, 175 cm.

Grab rail for vertical installation, 175 cm.

colori colours

G9 R2 P5 WE N2

G18UAS41 XX

€ 126,00 N2

€ 144,00 G9; P5; R2; WE

Carico Load ↓↘ 100 kg.

Peso Weight 2,2 kg.

Materiali Materials AI AL AB



Contenitore porta oggetti per installazione su maniglia verticale [LxPxA] 272x100x70 mm.

Objects container for vertical handle installation [WxDxH] 272x100x70 mm.

Colori colours

WE DD PB

Materiali Materials

PU

F47ANS01

€ 102,00

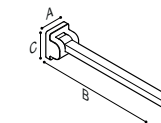

[AxBxC] 100x600x120 mm.

Sostegno ribaltabile, 60 cm. L'articolo può essere rimosso senza l'uso di strumenti specifici.

Folding grab bar, 60 cm. The product can be uninstalled without the use of any specific tools

colori colours
Braccio Arm

C1

Copri piastra Flange cover

WE D4 C1

Carico Load ↓↘ 150, →100 kg.

Peso Weight 2,7 kg.

Materiali Materials AI AL AB

G18JCS07 C1XX

€ 270,00 WE; D4

€ 290,00 C1



Porta rotolo inseribile su bracciolo [LxPxA] 25x160x63 mm.

Roll holder for installation on arm rest [WxDxH] 25x160x63 mm.

Colori colours

N2

Materiali Materials

AI

F18AGS01

€ 30,00

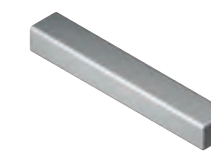

Poggia braccia [LxPxA] 50x300x39 mm.

Arm rest pad [WxDxH] 50x300x39 mm.

Colori colours

WE D4

Materiali Materials

PE

F18JMS01

€ 15,00



Copri piastra [LxPxA] 92x20x125 mm.

Fixing plate cover [WxDxH] 92x20x125 mm.

Colori colours

WE D4 C1

Materiali Materials

AB

F18JIS01

€ 10,00 WE; D4

€ 15,00 C1

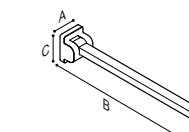

[AxBxC] 100x700x120 mm.

Sostegno ribaltabile, 70 cm. L'articolo può essere rimosso senza l'uso di strumenti specifici.

Folding grab bar, 70 cm. The product can be uninstalled without the use of any specific tools

colori colours
Braccio Arm

C1

Copri piastra Flange cover

WE D4 C1

Carico Load ↓↘ 150, →100 kg.

Peso Weight 3,0 kg.

Materiali Materials AI AL AB

G18JCS08 C1XX

€ 290,00 WE; D4

€ 310,00 C1



Porta rotolo inseribile su bracciolo [LxPxA] 25x160x63 mm.

Roll holder for installation on arm rest [WxDxH] 25x160x63 mm.

Colori colours

N2

Materiali Materials

AI

F18AGS01

€ 30,00

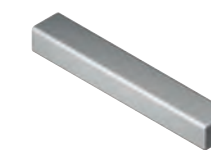

Poggia braccia [LxPxA] 50x300x39 mm.

Arm rest pad [WxDxH] 50x300x39 mm.

Colori colours

WE D4

Materiali Materials

PE

F18JMS01

€ 15,00



Copri piastra [LxPxA] 92x20x125 mm.

Fixing plate cover [WxDxH] 92x20x125 mm.

Colori colours

WE D4 C1

Materiali Materials

AB

F18JIS01

€ 10,00 WE; D4

€ 15,00 C1

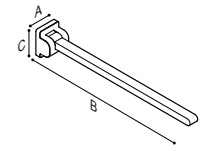

[AxBxC] 100x850x120 mm.

Sostegno ribaltabile, 85 cm.
L'articolo può essere
rimosso senza l'uso di
strumenti specifici.

Folding grab bar, 85 cm.
The product can be
uninstalled without the use
of any specific tools

colori colours

Braccio Arm



Copri piastra Flange cover



Carico Load ↓120, →100 kg.

Peso Weight 3,4 kg.

Materiali Materials **AI** **AL** **AB**

G18JCS09 C1XX

€ 340,00 WE; D4

€ 360,00 C1



Porta rotolo inseribile su
bracciolo

[LxPxA] 25x160x63 mm.

Roll holder for installation on arm
rest
[WxDxH] 25x160x63 mm.

Colori colours



Materiali Materials



F18AGS01

€ 30,00



Poggia braccia

[LxPxA] 50x300x39 mm.

Arm rest pad
[WxDxH] 50x300x39 mm.

Colori colours



Materiali Materials



F18JMS01

€ 15,00



Copri piastra

[LxPxA] 92x20x125 mm.

Fixing plate cover
[WxDxH] 92x20x125 mm.

Colori colours



Materiali Materials



F18JIS01

€ 10,00 WE; D4

€ 15,00 C1

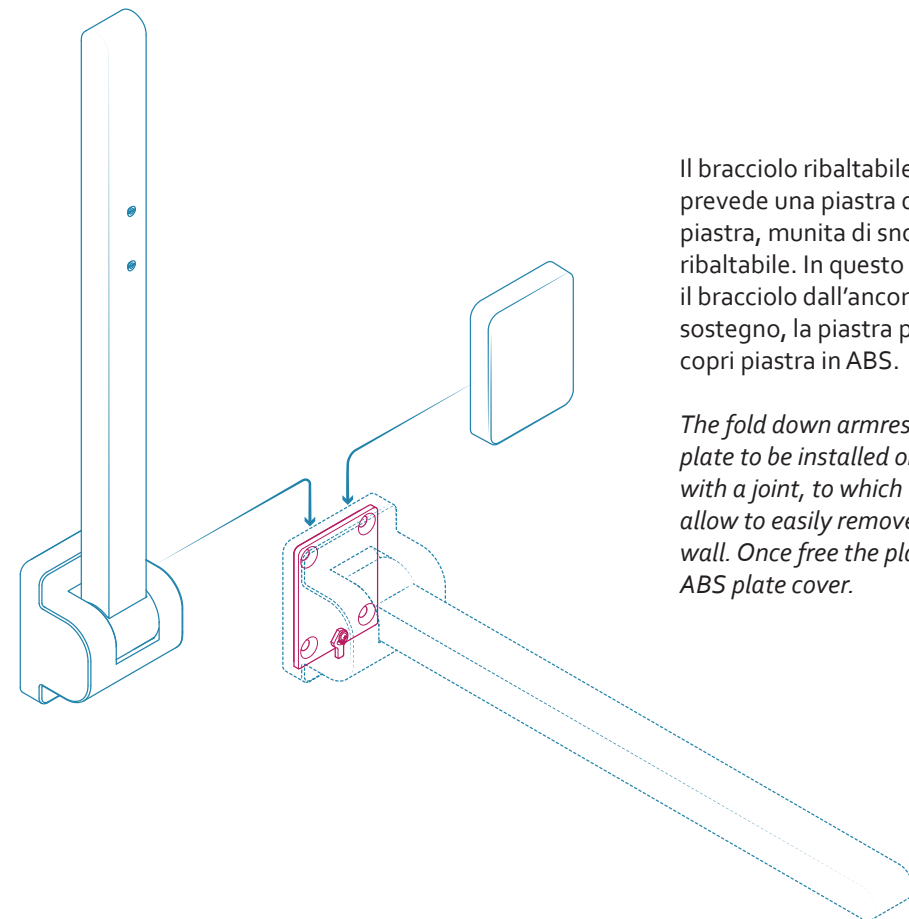

Il bracciolo ribaltabile ha un sistema di fissaggio che prevede una piastra da installare a parete, e una semi-piastra, munita di snodo, alla quale è fissato il braccio ribaltabile. In questo modo si può rimuovere facilmente il bracciolo dall'ancoraggio al muro. Una volta libera dal sostegno, la piastra può essere protetta da un elegante copri piastra in ABS.

The fold down armrest has a fixing system that includes a plate to be installed on the wall, and a semi-plate, equipped with a joint, to which the folding arm is fixed. This solution allow to easily remove the armrest from the anchor to the wall. Once free the plate can be protected by an elegant ABS plate cover.

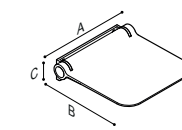

[AxBxC] 425x460x110 mm.

Sedile doccia ribaltabile

Folding shower seat

colori colours



Carico Load ↓ 150 kg.

Peso Weight 6,3 kg.

Materiali Materials **PU** **AI** **AL**

G12JDS05 XX

€ 380,00



Schienale per sedile doccia

[LxPxA] 420x40x270 mm.

Backrest for shower seat
[WxDxH] 420x40x270 mm.

Colori colours



Materiali Materials



G12JDS06 XX

€ 139,00



Schienale, munito di braccioli,
per sedile doccia

[LxPxA] 600x259x270 mm.

Backrest with armrests for
shower sea
[WxDxH] 600x259x270 mm.

Colori colours



Materiali Materials



G12JDS07 XX

€ 346,00

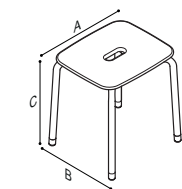

[AxBxC] 420x350x445 mm.

Sgabello

Stool

colori colours

Seduta Seat



Struttura Structure



Carico Load ↓ 150 kg.

Peso Weight 5 kg.

Materiali Materials **PU** **AI**

G12JDS02 XX XX

€ 255,00 N2; N1

€ 270,00 G9; P5; R2; WE

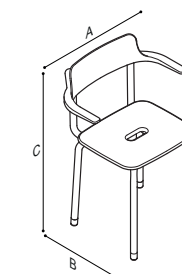

[AxBxC] 420x530x735 mm

Seggiola con schienale
munito di braccioli

Seat, with backrest and armrest

colori colours

Seduta Seat



Struttura Structure



Carico Load ↓ 150 kg.

Peso Weight 7,2 kg.

Materiali Materials **PU** **AI**

G12JDS04 XX XX

€ 466,00 N2; N1

€ 486,00 G9; P5; R2; WE

Nota

Per lo sgabello e la seggiola, sono possibili molteplici combinazioni di colore scegliendo sia il colore della seduta, sia quello della struttura.
In fase di ordine sostituire la coppia di **XX**, con il codice del colore della seduta, e la coppia **XX**, il codice del colore della struttura.

Note

Multiple color combinations are possible by choosing both the color of the seat and the structure for the stool and the chair.
When ordering, replace the **XX** pair, with the color of the seat color, and **XX** pair, with the color code of the structure.

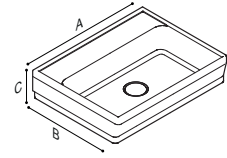

[AxBxC] 685x520x191 mm.

Lavabo
Washbasin

colori *colours*



WM

B48CMMo1

€ 545,00

Peso *Weight* 28 kg.

Materiali *Materials* CM



Tasselli di fissaggio
Fasteners

Colori *colours*

N.A.

Materiali *Materials*

N.A.

Y9oSES42

€ 6,50



Barra porta salviette, per lato sinistro
Left side towel holder bar

Colori *colours*



N2

Materiali *Materials*

Al

F47AML03

€ 91,00



Barra porta salviette, per lato destro
Right side towel holder bar

Colori *colours*



N2

Materiali *Materials*

Al

F47AMR03

€ 91,00

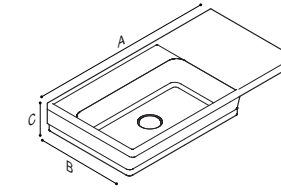

[AxBxC] 1000x520x191 mm.

Console con catino su lato sinistro
Console with left-hand basin

colori *colours*



WM

B48CNLo1

€ 610,00

Peso *Weight* 33 kg.

Materiali *Materials* CM



Tasselli di fissaggio
Fasteners

Colori *colours*

N.A.

Materiali *Materials*

N.A.

Y9oSES42

€ 6,50



Staffa di fissaggio sotto-piano
(vedi nota a piè di pagina)
Under-top fastening bracket
(see footnote)

Colori *colours*



WE

Materiali *Materials*

Al

B41DCR33

€ 56,00



Barra porta salviette, per lato sinistro
Left side towel holder bar

Colori *colours*



N2

Materiali *Materials*

Al

F47AML03

€ 91,00



Cassetto singolo per installazione sotto-piano
[LxPxA] 310x520x110 mm.
Single drawer for under-top basin installation
[WxDxH] 310x520x110 mm.

Colori *colours*



WD IB BZ

Materiali *Materials*

FM

F47AISo1 XX

€ 350,00



Cassettiera per installazione sotto-piano
[LxPxA] 310x520x420 mm.
Drawers for under-top basin installation
[LxPxA] 310x520x420 mm.

Colori *colours*



WD IB BZ

Materiali *Materials*

FM

F47AISo2 XX

€ 825,00

Nota

La console si installa con tasselli e viti, è prevista una staffa per l'ancoraggio a muro sotto-piano da acquistare, tassativamente, in caso di ordine della sola console. In caso di acquisto di cassettera o cassetto, la staffa non deve essere acquistata perché già inclusa con questi articoli.

Note

Dowels and screws should be used to install the console. A wall-mounting bracket, for under-top installation, ought to be purchased, in the case of console purchase only. When buying a drawer or drawers, the bracket should not be purchased because it is already included with these items.

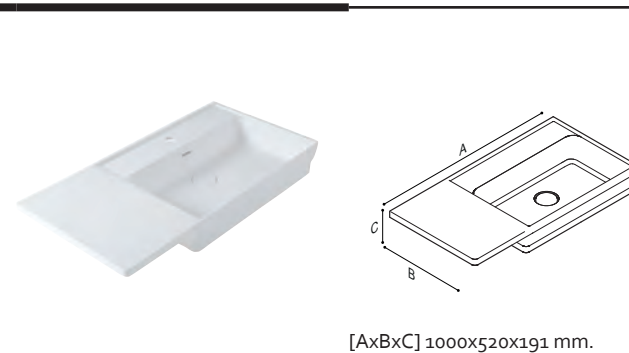

Console con catino su lato destro
Console with right-hand basin

colori *colours*
WM

B48CNR01
€ 610,00

Peso *Weight* 33 kg.
Materiali *Materials* CM

[AxBxC] 1000x520x191 mm.



Tasselli di fissaggio
Fasteners

Colori *colours*
N.A.

Y90SES42
€ 6,50

Materiali *Materials*
N.A.



Staffa di fissaggio sotto-piano
(vedi nota a piè di pagina)
Under-top fastening bracket
(see footnote)

Colori *colours*
WE

B41DCL33
€ 56,00

Materiali *Materials*
AI



Barra porta salviette, per lato destro
Right side towel holder bar

Colori *colours*
N2

F47AMR03
€ 91,00

Materiali *Materials*
AI



Cassetto singolo per installazione sotto-piano
[LxPxA] 310x520x110 mm.
Single drawer for under-top basin installation
[WxDxH] 310x520x110 mm.

Colori *colours*
WD IB BZ

F47AIS01 XX
€ 350,00

Materiali *Materials*
FM



Cassettiera per installazione sotto-piano
[LxPxA] 310x520x420 mm.
Drawers for under-top basin installation
[LxPxA] 310x520x420 mm.

Colori *colours*
WD IB BZ

F47AIS02 XX
€ 825,00

Materiali *Materials*
FM

Nota

La consolle si installa con tasselli e viti, è prevista una staffa per l'ancoraggio a muro sotto-piano da acquistare, tassativamente, in caso di ordine della sola consolle. In caso di acquisto di cassettera o cassetto, la staffa non deve essere acquistata perché già inclusa con questi articoli.

Note

Dowels and screws should be used to install the console. A wall-mounting bracket, for under-top installation, ought to be purchased, in the case of console purchase only. When buying a drawer or drawers, the bracket should not be purchased because it is already included with these items.

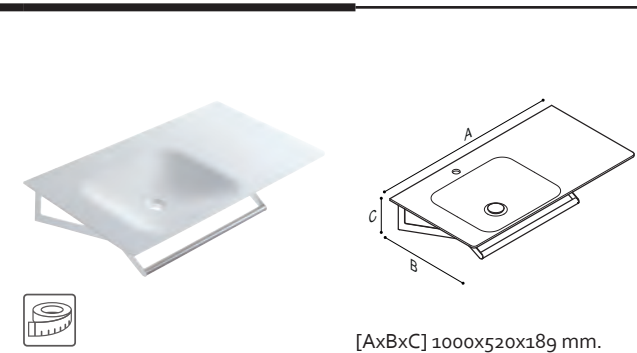

Console con catino su lato sinistro, munito di braccio porta telo.
personalizzabile su misura
Console with left-hand basin, towel bar provided.
Customisable on request

colori *colours*
Consolle *Console*
WE

Maniglia di sicurezza *Grab bar*
G9 R2 P5 WE N2

B46CML22
€ 825,00 N2
G9; P5; R2; WE

Peso *Weight* 11 kg.
Materiali *Materials* PA

[AxBxC] 1000x520x189 mm.



Staffa di fissaggio sotto-piano
(vedi nota a piè di pagina)
Under-top fastening bracket
(see footnote)

Colori *colours*
WE

B41DCR34
€ 56,00

Materiali *Materials*
AI



Piletta a passaggio libero, con tappo cromato
Drain, with chromed top

Colori *colours*
C1

H52HAS14
€ 36,37

Materiali *Materials*
AB



Piletta a passaggio libero, con tappo in pietra acrilica
Drain, with solid surface top

Colori *colours*
C1

H52HAM16
€ 89,72

Materiali *Materials*
AB PA



Piletta a passaggio libero, sifonata e ribassata
Siphoned and lowered drain

Colori *colours*
N.A.

H52HAS22
€ 44,00

Materiali *Materials*
N.A.



Cassetto singolo per installazione sotto-piano
[LxPxA] 310x520x110 mm.
Single drawer for under-top basin installation
[WxDxH] 310x520x110 mm.

Colori *colours*
WD IB BZ

F47AIS01 XX
€ 350,00

Materiali *Materials*
FM



Cassettiera per installazione sotto-piano
[LxPxA] 310x520x420 mm.
Drawers for under-top basin installation
[LxPxA] 310x520x420 mm.

Colori *colours*
WD IB BZ

F47AIS02 XX
€ 825,00

Materiali *Materials*
FM

Nota

La consolle si installa con tasselli e viti, è prevista una staffa per l'ancoraggio a muro sotto-piano da acquistare, tassativamente, in caso di ordine della sola consolle. In caso di acquisto di cassettera o cassetto, la staffa non deve essere acquistata perché già inclusa con questi articoli.

Note

Dowels and screws should be used to install the console. A wall-mounting bracket, for under-top installation, ought to be purchased, in the case of console purchase only. When buying a drawer or drawers, the bracket should not be purchased because it is already included with these items.

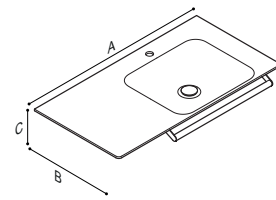

[AxBxC] 1000x520x189 mm.

Console con catino su lato destro, munito di braccio porta telo.
personalizzabile su misura
Console with left-hand basin, towel bar provided.
Customisable on request

colori colours



W3

B46CMR22

€ 825,00

Peso Weight 11,6 kg.

Materiali Materials PA



Staffa di fissaggio sotto-piano (vedi nota a piè di pagina)
Under-top fastening bracket (see footnote)

Colori colours



WE

B41DCL34

€ 56,00

Materiali Materials



Piletta a passaggio libero, con tappo cromato
Drain, with chromed top

Colori colours



C1

H52HAS14

€ 36,37

Materiali Materials



Piletta a passaggio libero, con tappo in pietra acrilica
Drain, with solid surface top

Colori colours



C1

H52HAM16

€ 89,72

Materiali Materials



Piletta a passaggio libero, sifonata e ribassata
Siphoned and lowered drain

Colori colours

N.A.

H52HAS22

€ 44,00

Materiali Materials

N.A.



Cassetto singolo per installazione sotto-piano [LxPxA] 310x520x110 mm.
Single drawer for under-top basin installation [WxDxH] 310x520x110 mm.

Colori colours



WD

IB

BZ

F47AIS01 XX

€ 350,00

Materiali Materials



Cassettiera per installazione sotto-piano [LxPxA] 310x520x420 mm.
Drawers for under-top basin installation [LxPxA] 310x520x420 mm.

Colori colours



WD

IB

BZ

F47AIS02 XX

€ 825,00

Materiali Materials



Nota

La consolle si installa con tasselli e viti, è prevista una staffa per l'ancoraggio a muro sotto-piano da acquistare, tassativamente, in caso di ordine della sola consolle. In caso di acquisto di cassettera o cassetto, la staffa non deve essere acquistata perché già inclusa con questi articoli.

Note

Dowels and screws should be used to install the console. A wall-mounting bracket, for under-top installation, ought to be purchased, in the case of console purchase only. When buying a drawer or drawers, the bracket should not be purchased because it is already included with these items.

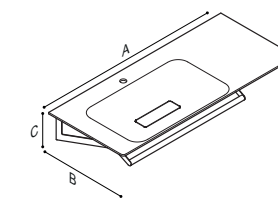

[AxBxC] 1200x520x189 mm.

Console con catino su lato sinistro, munito di braccio porta telo.
personalizzabile su misura
Console with left-hand basin, towel bar provided.
Customisable on request

colori colours



W3

B46CML23

€ 1.455,00

Peso Weight 15 kg.

Materiali Materials PA



Staffa di fissaggio sotto-piano (vedi nota a piè di pagina)
Under-top fastening bracket (see footnote)

Colori colours



WE

B41DCR34

€ 56,00

Materiali Materials



Piletta a passaggio libero, con tappo cromato
Drain, with chromed top

Colori colours



C1

H52HAS14

€ 36,37

Materiali Materials



Piletta a passaggio libero, sifonata e ribassata
Siphoned and lowered drain

Colori colours

N.A.

H52HAS22

€ 44,00

Materiali Materials

N.A.

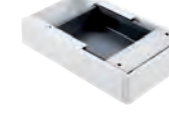

Cassetto singolo per installazione sotto-piano [LxPxA] 310x520x110 mm.
Single drawer for under-top basin installation [WxDxH] 310x520x110 mm.

Colori colours



WD

IB

BZ

F47AIS01 XX

€ 350,00

Materiali Materials



Cassettiera per installazione sotto-piano [LxPxA] 310x520x420 mm.
Drawers for under-top basin installation [LxPxA] 310x520x420 mm.

Colori colours



WD

IB

BZ

F47AIS02 XX

€ 825,00

Materiali Materials



Nota

La consolle si installa con tasselli e viti, è prevista una staffa per l'ancoraggio a muro sotto-piano da acquistare, tassativamente, in caso di ordine della sola consolle. In caso di acquisto di cassettera o cassetto, la staffa non deve essere acquistata perché già inclusa con questi articoli.

Note

Dowels and screws should be used to install the console. A wall-mounting bracket, for under-top installation, ought to be purchased, in the case of console purchase only. When buying a drawer or drawers, the bracket should not be purchased because it is already included with these items.

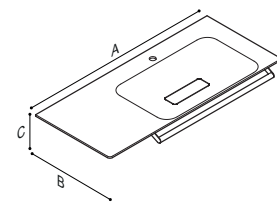

[AxBxC] 1200x520x189 mm.

Console con catino su lato destro, munito di braccio porta telo.
personalizzabile su misura
Console with left-hand basin, towel bar provided.
Customisable on request

colori colours



B46CMR23

€ 1.455,00

Peso Weight 15 kg.

Materiali Materials PA



Staffa di fissaggio sotto-piano (vedi nota a piè di pagina)
Under-top fastening bracket (see footnote)

Colori colours



B41DCL34

€ 56,00

Materiali Materials



Piletta a passaggio libero, con tappo cromato
Drain, with chromed top

Colori colours



H52HAS14

€ 36,37

Materiali Materials



Piletta a passaggio libero, sifonata e ribassata
Siphoned and lowered drain

Colori colours

N.A.

H52HAS22

€ 44,00

Materiali Materials

N.A.

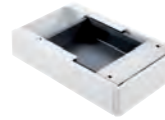

Cassetto singolo per installazione sotto-piano [LxPxA] 310x520x110 mm.
Single drawer for under-top basin installation [WxDxH] 310x520x110 mm.

Colori colours



F47AIS01 XX

€ 350,00

Materiali Materials



Cassettiera per installazione sotto-piano [LxPxA] 310x520x420 mm.
Drawers for under-top basin installation [LxPxA] 310x520x420 mm.

Colori colours



F47AIS02 XX

€ 825,00

Materiali Materials



Nota

La console si installa con tasselli e viti, è prevista una staffa per l'ancoraggio a muro sotto-piano da acquistare, tassativamente, in caso di ordine della sola console. In caso di acquisto di cassettera o cassetto, la staffa non deve essere acquistata perché già inclusa con questi articoli.

Note

Dowels and screws should be used to install the console. A wall-mounting bracket, for under-top installation, ought to be purchased, in the case of console purchase only. When buying a drawer or drawers, the bracket should not be purchased because it is already included with these items.

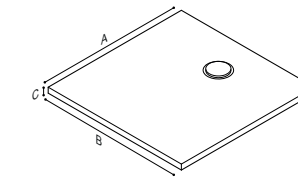

[AxBxC] 900x900x55 mm.

Piatto doccia quadrato, con superficie punteggiata a rilievo
Squared shower tray, with relief dotted surface

colori colours



B48CPM02

€ 478,00

Peso Weight 33 kg.

Materiali Materials CM



Piletta di scarico senza copertura
Siphoned drain

Colori colours

N.A.

H52HAS07

€ 39,00

Materiali Materials

N.A.

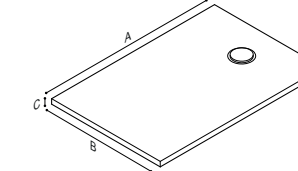

[AxBxC] 1200x800x55 mm.

Piatto doccia rettangolare, con superficie punteggiata a rilievo
Rectangular shower tray, with relief dotted surface

colori colours



B48CPM03

€ 508,00

Peso Weight 40 kg.

Materiali Materials CM



Piletta di scarico senza copertura
Siphoned drain

Colori colours

N.A.

H52HAS07

€ 39,00

Materiali Materials

N.A.

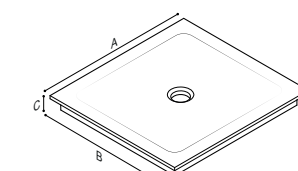

[AxBxC] 800/1700x700/800x70 mm.

Piatto doccia quadrato personalizzabile su misura
Squared shower tray Customisable on request

colori colours



B46CPM21

€ 724,50 800/1000x700/800x70

B46CPM22

€ 745,50 1000/1100x700/800x70

B46CPM23

€ 766,50 1200/1400x700/800x70

B46CPM24

€ 913,50 1500/1700x700/800x70

Materiali Materials PA

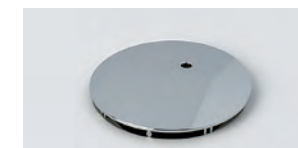

Piletta di scarico con copertura finitura cromo
Siphoned drain

Colori colours



H52HAS12

€ 41,35

Materiali Materials

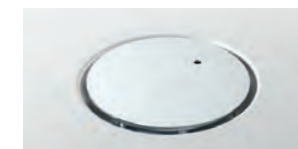

Piletta di scarico, filo piatto, con copertura finitura cromo
Siphoned drain

Colori colours



H52HAS06

€ 65,10

Materiali Materials



Per altri piatti in pietra acrilica consultare il catalogo generale nr.:19 - pagg. 290-291 - Further acrylic stone shower trays on general catalog no.:19 - pages 290-291

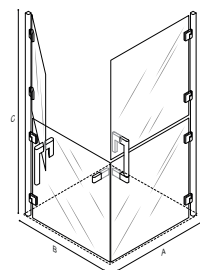

Box doccia con ante sdoppiate
90x90 cm.
*Split doors shower enclosure
90x90 cm.*

[AxBxC] 900x900x1950 mm.

Peso *Weight* 53 kg.
Materiali *Materials* AL CV AB

C53FBS21
€ 840,00

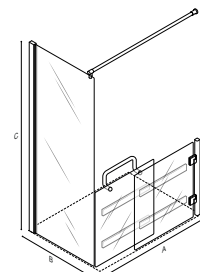

Box doccia con pannello fisso,
anta con pannello scorrevole
basso, completo di asta, tenda
in PVC e ganci. 120x80 cm.
VERSIONE DESTRA
*Low sliding door, with fix panel
and curtain shower enclosure,
120x80 cm.
Right version*

[AxBxC] 1200x800x1950 mm.

Peso *Weight* 48 kg.
Materiali *Materials* AL CV AB

C53FBR23
€ 950,00

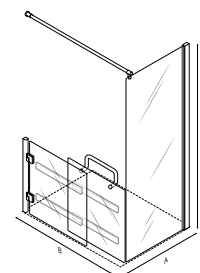

Box doccia con pannello fisso,
anta con pannello scorrevole
basso, completo di asta, tenda
in PVC e ganci. 120x80 cm.
VERSIONE SINISTRA
*Low sliding door, with fix panel
and curtain shower enclosure,
120x80 cm.
Left version*

[AxBxC] 1200x800x1950 mm.

Peso *Weight* 48 kg.
Materiali *Materials* AL CV AB

C53FBL23
€ 950,00

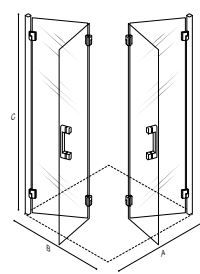

Box doccia con ante a libro,
90x90 cm.
*Accordion doors shower
enclosure, 90x90 cm.*

[AxBxC] 900x900x1950 mm.

Peso *Weight* 54 kg.
Materiali *Materials* AL CV AB

C53FBS24
€ 840,00

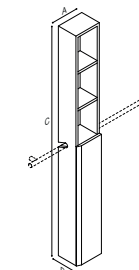

Mobile contenitore con
mensole da agganciare su
sostegno orizzontale
*Cabinet with shelf to hung on
horizontal grab bar*

[AxBxC] 200x170x1700 mm.

colori *colours*
BZ IB WD

Peso *Weight* 14 kg.
Materiali *Materials* FM

F47APS07 XX
€ 810,00

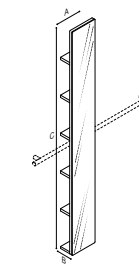

Specchiera con mensole
da agganciare su sostegno
orizzontale
*Mirror with shelves to hung on
horizontal grab bar*

[AxBxC] 200x100x1700 mm.

colori *colours*
BZ IB WD

Peso *Weight* 13 kg.
Materiali *Materials* FM CV

F47ATS17 XX
€ 558,00

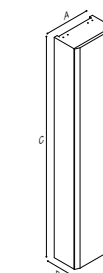

Mobile contenitore a parete
Wall hung cabinet

[AxBxC] 300x171x1500 mm.

colori *colours*
BZ IB WD

Peso *Weight* 18 kg.
Materiali *Materials* FM

F47APS08 XX
€ 780,00



Staffe per fissaggio a muro.
Per installazione senza maniglia.
*Wall brackets
For installation without
handle.*

Colori *colours*
N.A.
Materiali *Materials*
AI

B41DCS35
€ 35,00



Maniglia munita di staffe di
fissaggio per l'installazione del
mobile contenitore
REVERSIBILE
*Handle provided of fixing
brackets for cabinet
installation
Reversible*

Colori *colours*
G9 R2 P5 WE N2
Materiali *Materials*
AI AL

F18UWS02 XX
€ 155,00 N2; N1
€ 175,00 G9; P5; R2; WE

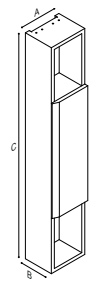
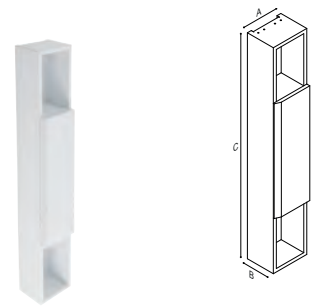

Mobile contenitore a parete con mensole
Wall hung cabinet, with shelves

colori colours



F47APSo6 XX

€ 505,00

Peso Weight 9 kg.

Materiali Materials FM

[AxBxC] 200x171x1170 mm.



Staffe per fissaggio a muro. Per installazione senza maniglia.
Wall brackets For installation without handle.

Colori colours

N.A.

Materiali Materials

AI

B41DCS34

€ 35,00



Maniglia munita di staffe di fissaggio per l'installazione del mobile contenitore REVERSIBILE
Handle provided of fixing brackets for cabinet installation Reversible

Colori colours



F18UWS01 XX

€ 125,00 N2; N1

€ 141,00 G9; P5; R2; WE

Materiali Materials

AI AL



Gancio appendi abiti
Hook hang clothes

colori colours



F18AKSo2 XX

€ 25,00 N2

€ 28,00 G9; P5; R2; WE

Peso Weight 0,15 kg.

Materiali Materials AI AL AB

[AxBxC] 40x50x40 mm.



Porta rotolo
Roll paper holder

colori colours



F18AGSo3 XX

€ 32,00 N2

€ 36,00 G9; P5; R2; WE

Peso Weight 0,20 kg.

Materiali Materials AI AL AB

[AxBxC] 40x110x40 mm.

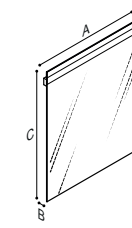

Specchio inclinabile, spessore 5 mm., con sistema di illuminazione LED integrato ed interruttore con sensore a sfioro

Tilting mirror, 5 mm. thick, with integrated LED lighting system and sensor switch

F47JPS03

€ 425,00

Peso Weight 7 kg.

Materiali Materials CV

[AxBxC] 680x80x750 mm.

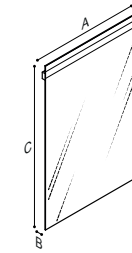

Specchio fisso, spessore 5 mm., con sistema di illuminazione LED integrato ed interruttore con sensore a sfioro

Mirror, 5 mm. thick, with integrated LED lighting system and sensor switch

F47ATS18

€ 406,00

Peso Weight 8,5 kg.

Materiali Materials CV

[AxBxC] 660x27x950 mm.

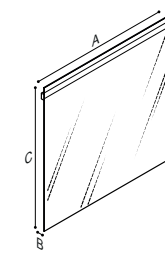

Specchio fisso, spessore 5 mm., con sistema di illuminazione LED integrato ed interruttore con sensore a sfioro

Mirror, 5 mm. thick, with integrated LED lighting system and sensor switch

F47ATS19

€ 530,00

Peso Weight 13 kg.

Materiali Materials CV

[AxBxC] 1000x27x950 mm.



Articoli di complemento suggeriti

Suggested items for matching



Miscelatore per lavabo "Logis 70"
Washbasin mixer

H51GBS02
€ 130,00



Miscelatore per bidet "Logis 70"
Bidet mixer

H51GBS03
€ 130,00



Placca e leva miscelatore, incasso, per doccia "Logis 70"
Shower recessed mixer plaque and lever

H51GBS04
€ 167,00



Corpo incasso universale per miscelatore doccia
Universal basic set suitable for all sets for concealed installation

Y51GIS03
€ 172,00



Soffione anticalcare "slim" ø 30 cm.
Shower head "slim" ø 30 cm.

Colori colours
N2

H51GNS02
€ 175,00

Peso Weight 1,6 kg.
Materiali Materials Al



Braccio per installazione soffione a parete
Wall shower arm

Colori colours
C1

H51GHS40
€ 55,00

Materiali Materials
N.A.



Braccio per installazione soffione a soffitto
Ceiling shower arm

Colori colours
C1

H51GHS39
€ 60,00

Materiali Materials
N.A.



Soffione anticalcare "slim" 30x30 cm.
Shower head "slim" 30x30 cm.

Colori colours
C1

H51GNS01
€ 190,00

Peso Weight 1,8 kg.
Materiali Materials Al



Braccio per installazione soffione a parete.
Wall shower arm

Colori colours
C1

H51GHS40
€ 55,00

Materiali Materials
N.A.



Braccio per installazione soffione a soffitto.
Ceiling shower arm

Colori colours
C1

H51GHS39
€ 60,00

Materiali Materials
N.A.

Articoli di complemento suggeriti *Suggested items for matching*

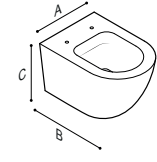

[AxBxC] 350x500x390 mm.

Vaso sanitario, senza brida
sospeso
Rimless wall hung WC

colori *colours*

B43CASo2

€ 287,00

Peso *Weight* 26 kg.

Materiali *Materials* PS



Kit di fissaggio rapido
Fixing set

Colori *colours*

N.A.

Materiali *Materials*

N.A.

Y96SES94

€ 28,00



Staffa di fissaggio per sanitario
sospeso
*Fixing bracket for
suspended sanitaryware*

Colori *colours*

N.A.

Materiali *Materials*

N.A.

B41DDSo1

€ 52,90



Sedile con copri sedile, soft close
*Seat , with seat cover, soft
close*

Colori *colours*

N.A.

Materiali *Materials*

RU

B41DES11

€ 119,00

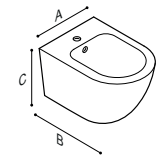

[AxBxC] 350x500x340 mm.

Bidet sospeso
Wall hung bidet

colori *colours*

B43CHSo2

€ 287,00

Peso *Weight* 21 kg.

Materiali *Materials* PS



Kit di fissaggio rapido
Fixing set

Colori *colours*

N.A.

Materiali *Materials*

N.A.

Y96SES94

€ 28,00



Staffa di fissaggio per sanitario
sospeso
*Fixing bracket for
suspended sanitaryware*

Colori *colours*

N.A.

Materiali *Materials*

N.A.

B41DDSo1

€ 52,90

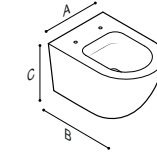

[AxBxC] 350x550x390 mm.

Vaso sanitario, senza brida
sospeso
Rimless wall hung WC

colori *colours*

B43CASo3

€ 330,00

Peso *Weight* 28 kg.

Materiali *Materials* PS



Kit di fissaggio rapido
Fixing set

Colori *colours*

N.A.

Materiali *Materials*

N.A.

Y96SES94

€ 28,00



Staffa di fissaggio per sanitario
sospeso
*Fixing bracket for
suspended sanitaryware*

Colori *colours*

N.A.

Materiali *Materials*

N.A.

B41DDSo1

€ 52,90



Sedile con copri sedile, soft close
*Seat , with seat cover, soft
close*

Colori *colours*

N.A.

Materiali *Materials*

RU

B41DES11

€ 119,00

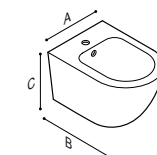

[AxBxC] 350x550x340 mm.

Bidet sospeso
Wall hung bidet

colori *colours*

B43CHSo3

€ 330,00

Peso *Weight* 23 kg.

Materiali *Materials* PS



Kit di fissaggio rapido
Fixing set

Colori *colours*

N.A.

Materiali *Materials*

N.A.

Y96SES94

€ 28,00



Staffa di fissaggio per sanitario
sospeso
*Fixing bracket for
suspended sanitaryware*

Colori *colours*

N.A.

Materiali *Materials*

N.A.

B41DDSo1

€ 52,90

Articoli di complemento suggeriti *Suggested items for matching*

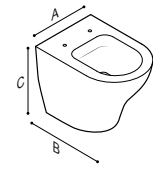

[AxBxC] 350x540x420 mm.

Vaso sanitario, senza brida
Rimless WC

colori *colours*



B43CBS02

€ 287,00

Peso *Weight* 29 kg.

Materiali *Materials* PS



Kit di fissaggio rapido
Fixing set

Colori *colours*

N.A.

Materiali *Materials*

N.A.

Y96SES95

€ 24,00



Sedile con copri sedile, soft close
Seat , with seat cover, soft close

Colori *colours*

N.A.

Materiali *Materials*

RU

B41DES11

€ 119,00

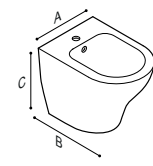

[AxBxC] 350x540x420 mm.

Bidet
Bidet

colori *colours*



B43CIS02

€ 287,00

Peso *Weight* 25 kg.

Materiali *Materials* PS



Kit di fissaggio rapido
Fixing set

Colori *colours*

N.A.

Materiali *Materials*

N.A.

Y96SES95

€ 24,00

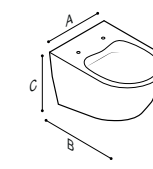

[AxBxC] 360x530x335 mm.

Vaso sanitario, senza brida,
sospeso
Rimless wall hung WC

colori *colours*



B43CAS04

€ 387,00

Peso *Weight* 33 kg.

Materiali *Materials* PS



Sedile con copri sedile
Seat , with seat cover

Colori *colours*

N.A.

Materiali *Materials*

RU

B41DES12

€ 95,00



Sedile con copri sedile, soft close
Seat , with seat cover, soft close

Colori *colours*

N.A.

Materiali *Materials*

RU

B41DES13

€ 166,00

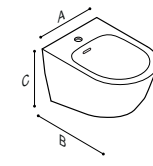

[AxBxC] 360x530x335 mm.

Bidet, sospeso
Wall hung bidet

colori *colours*



B43CHS04

€ 298,00

Peso *Weight* 23 kg.

Materiali *Materials* PS

Articoli di complemento suggeriti *Suggested items for matching*

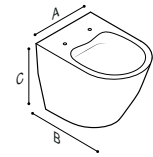

[AxBxC] 360x530x430 mm.

Vaso sanitario, senza brida
Rimless wall hung WC

colori *colours*

B43CBS03

€ 352,00

WB

Peso *Weight* 21 kg.

Materiali *Materials* PS



Sedile con copri sedile
Seat , with seat cover

Colori *colours*

B41DES12

€ 95,00

N.A.

Materiali *Materials*

RU



Sedile con copri sedile, soft close
Seat , with seat cover, soft close

Colori *colours*

B41DES13

€ 166,00

N.A.

Materiali *Materials*

RU

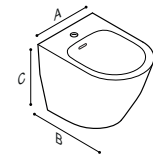

[AxBxC] 360x530x430 mm.

Bidet
Bidet

colori *colours*

B43CIS03

€ 284,00

WB

Peso *Weight* 17 kg.

Materiali *Materials* PS



Condizioni di vendita *Terms and conditions of sale*

Mercato Italiano

1. Ponte Giulio S.p.A. si riserva il diritto di apportare ai suoi prodotti variazioni nelle misure ed eventuali accorgimenti tecnici senza dover dare alcun preavviso ai clienti.
2. I prezzi si intendono per merce resa franco stabilimento di Orvieto, I.V.A. esclusa.
3. I prezzi possono variare senza preavviso.
4. Effettuiamo la consegna con corrieri di nostra fiducia alle seguenti condizioni:
 - fino a € 400,00 addebito fisso € 29,00;
 - da € 400,01 a € 800,00 addebito dell'8%;
 - da € 800,01 a € 1.300,00 addebito del 6%;
 - da € 1.300,01 a € 2.500,00 addebito del 5%;
 - oltre addebito del 3%.
 - Per consegne ordinarie di merce non danneggiabile ed in piccole quantità (massimo 30 kg), saranno utilizzati corrieri espressi alle condizioni sopra riportate.
 - Se saranno richieste spedizioni (escluso articoli in porcellana sanitaria), anche voluminose, con corrieri espressi o con servizio di spedizione veloce "subito", addebito al costo.
5. Per il confezionamento dei materiali ceramici su pallet e/o scatole di cartone opportunamente rinforzate, sarà addebitato l'imballo in ragione dell'1,5%.
6. La merce viaggia a rischio e pericolo del committente. Il destinatario è tenuto a controllare la merce all'arrivo e contestare eventuali danni direttamente al vettore anche quando la merce è recapitata in porto franco.
7. Qualora non sia possibile effettuare il controllo all'atto dello scarico della merce, il cliente potrà accettare il materiale apponendo la clausola "con riserva di verifica del contenuto" sul D.d.T. e sulla lettera di vettura del corriere e contestare eventuali danni nel termine di 8 giorni dal ricevimento a mezzo raccomandata, fax al +39 0763 316043 o posta elettronica. La Ponte Giulio S.p.A. non accetterà reclami se non sarà rispettata la procedura sopra indicata.
8. La Ponte Giulio S.p.A. si riserva il diritto di effettuare anche consegne parziali di ordini. I termini di consegna saranno rispettati salvo causa di forza maggiore o indipendenti dalla volontà della Ponte Giulio S.p.A. quali contingentamenti, scioperi, mancanza di trasporti, ecc.. In tali casi il committente non ha diritto al risarcimento di danni o rimborsi.
9. Nessun articolo può essere reso senza esplicita autorizzazione. L'autorizzazione al reso dovrà essere richiesta a mezzo fax o email alla direzione commerciale della Ponte Giulio S.p.A. specificando qualità e quantità dei materiali da rendere e ragioni del reso. La Ponte Giulio S.p.A., a propria discrezione, autorizzerà il reso con comunicazione a mezzo fax o posta elettronica.
10. I resi autorizzati, che potranno riguardare solo materiali di serie e produzione corrente, dovranno pervenire in fabbrica in porto franco e saranno accreditati nella misura del 90% del prezzo di vendita originario salvo eventuale ulteriore addebito delle spese di ripristino dovute a manomissioni o cagionati da incuria da parte del cliente. Non potranno comunque essere restituiti materiali su misura o colorati.
11. Le presenti condizioni di vendita s'intendono tutte accettate dal cliente con l'ordine.
12. Gli ordini espletati e fatturati anche in parte saranno regolati alle condizioni stabilite, intendendosi che i pagamenti delle merci spedite non potranno essere subordinati al completamento dell'ordine.
13. È facoltà della Ponte Giulio S.p.A. dare, sotto forma di sconto in natura, pannelli, espositori o attrezzature similari atte ad esporre i nostri prodotti nei punti vendita della nostra clientela.
14. Ponte Giulio S.p.A. normalmente non prende in considerazione ordini di prodotti diversi da quelli contemplati a listino. Ponte Giulio S.p.A. si riserva di valutare di volta in volta la fattibilità e la consistenza di ordini speciali a condizioni di prezzo che saranno stabilite per singolo ordine.
15. L'accettazione degli ordini è soggetta all'approvazione della direzione della Ponte Giulio S.p.A..
16. I pagamenti concordati sono sempre indicati in fattura; l'inosservanza dei termini di pagamento determinerà l'addebito, da parte della Ponte Giulio S.p.A., degli interessi di mora ai sensi dell'art. 5 del D. L.vo 9 ottobre 2002 n. 231. Per i pagamenti con tratte o ricevute bancarie saranno addebitate le spese di incasso e bollo. Il mancato pagamento alla scadenza convenuta, anche di una sola rata, autorizzerà la Ponte Giulio S.p.A. a sospendere l'evasione di tutti gli ordini in corso.
17. La Ponte Giulio S.p.A. mantiene la proprietà della merce fino all'integrale pagamento della relativa fattura di vendita.
18. Per qualsiasi controversia è competente solo ed esclusivamente il foro di Terni quale foro convenzionale indicato dalle parti. Il contenuto di tale clausola è stato oggetto di trattativa individuale tra le parti.

Foreign markets

1. *Ponte Giulio S.p.A. reserves the right to change the products dimensions and any technical features without any prior notice.*
2. *Prices are EXW factory Orvieto, Italy.*
3. *Prices might change without any prior notice.*
4. *Goods travel at customer's risk. The receiver will inspect the products upon their delivery and report any damages to the forwarder.*
5. *If the receiver is unable to check the goods upon their delivery, he can accept them and report any damages within 8 days.*
6. *Ponte Giulio S.p.A. reserves the right to make partial shipments. Ponte Giulio S.p.A. will meet the shipping terms except in those cases due to force majeure or beyond the will of Ponte Giulio S.p.A. such as curtailments, strikes, lack of transportation etc. In such cases the customer has no right to compensation or refund.*
7. *Products cannot be returned without authorisation from Ponte Giulio S.p.A. The authorisation must be requested to Ponte Giulio S.p.A. in writing via email specifying the quality and quantity of products involved and reason for returning them. Ponte Giulio S.p.A. will authorise, at its discretion, the return by confirmation in writing.*
8. *Returns will be authorised only for products which are standard and currently in production with transportation at the expense of the customer. Ponte Giulio S.p.A. will refund 90% of the original sale price except any additional charges for restoration due to alteration or caused by negligence of the customer. Coloured or custom made products can not be returned.*
9. *These sales conditions are deemed accepted by the customer when the order is placed.*
10. *Orders which are fulfilled and invoiced, even partially, will be subject to the conditions decided upon. Payments for shipped goods will not depend on the order fulfilment.*
11. *It's Ponte Giulio's discretion to provide, in the form of discount, panels, displays or similar tools aimed at exhibiting the products.*
12. *Usually Ponte Giulio do not accept orders for products different from those in the catalogue. However Ponte Giulio reserves the right to assess the feasibility and size of special orders at prices that will be calculated at each time.*
13. *The acceptance of orders is subject to the approval from Ponte Giulio S.p.A. The agreed payment terms are always shown in the invoice. In case of non-fulfillment of the payment conditions, Ponte Giulio S.p.A. will be entitled to add charges for interest on arrears payments, with reference to terms released by Euribor. Failure to meet an invoice due date, Ponte Giulio S.p.A. is authorised to stop the fulfilment of all pending orders.*
14. *Ponte Giulio S.p.A. keeps the property of goods until the total payment of the relevant invoice.*
15. *For any dispute the court of Terni, Italy is the only one in charge. The content of this clause has been object of individual agreement between the parties.*

INFORMATIVA SULLA PROTEZIONE DEI DATI PERSONALI
(ai sensi dell'articolo 13, decreto legislativo 196 del 30.06.2003)

"Codice in materia di protezione dei dati personali".
La società Ponte Giulio S.p.A., titolare del trattamento dei dati inerenti ai rapporti commerciali esistenti e futuri con i propri clienti, in ottemperanza al disposto dell'art.13 del Decreto Legislativo 30.06.2003 n. 196 "Codice in materia di protezione dei dati personali", rende la seguente informativa sul trattamento dei dati personali dei propri clienti:

- I dati sono raccolti per finalità contrattuali, commerciali, statistiche e promozionali.
- Il trattamento viene effettuato per mezzo di supporti informatici, telematici, magnetici e cartacei.
- La raccolta dei dati è obbligatoria al fine di ottemperare a tutti gli obblighi contabili, legali e commerciali. Il mancato conferimento dei dati che non siano riconducibili ad obblighi legali o contrattuali verrà valutato di volta in volta dal Titolare del trattamento che determinerà le conseguenti decisioni rapportate all'importanza dei dati richiesti rispetto alla gestione del rapporto commerciale.
- I destinatari dei dati, ferme restando le comunicazioni e diffusioni effettuate in esecuzione di obblighi di legge, potranno essere i seguenti soggetti: personale dell'azienda secondo le aree di competenza (commerciale, produzione, amministrazione,) agenti e rappresentanti della scrivente, società di factoring, società di recupero crediti, società di assicurazione crediti, istituti di credito, società di leasing, professionisti e consulenti, società di elaborazione dati, società di informazioni commerciali, aziende operanti nel settore del trasporto.
- I dati verranno trattati per tutta la durata dei rapporti contrattuali instaurati ed anche successivamente per l'espletamento di tutti gli adempimenti di legge nonché per future finalità commerciali e di marketing, in relazione ad operazioni promozionali e di vendita dei prodotti, effettuate attraverso l'invio di materiale pubblicitario o l'utilizzazione di altri sistemi di comunicazione commerciale.
- L'interessato potrà esercitare i diritti di cui all'art. 7 del Decreto Legislativo 30.06.2003 n. 196.
- Il Titolare del trattamento dei dati è Ponte Giulio S.p.A., Loc. Ponte Giulio snc, 05018 Orvieto (TR).
- Per contattare il Responsabile del trattamento, designato ai fini dell'art. 7 del Decreto Legislativo 30.06.2003 n. 196, potrete rivolgervi al seguente indirizzo: Orvieto, Loc. Ponte Giulio snc - Tel. 0763316044 - E-mail: privacy@pontegiulio.it.

Questo documento è stato realizzato nel più ampio rispetto dell'ambiente possibile. Sugeriamo, anche a coloro i quali si troveranno ad usarlo, di contribuire a questo scopo passandolo, dopo la consultazione, ad altre persone, oppure riciclandolo.

The catalogue has been produced in an environmentally responsible way, avoiding, as much as possible, the use of substances that may be hazardous for the health and the environment. We ask you to recycle it at the end of its life or when you do not need it anymore.

Le informazioni e i dati forniti in questo documento, pur se verificati e compilati con la massima attenzione, non possono essere ritenuti vincolanti. Ponte Giulio si riserva il diritto di apportare modifiche, anche senza preavviso, allo scopo di migliorare le caratteristiche dei propri prodotti.

The information and technical data shown in this catalogue, even if carefully checked and studied, can not be considered binding and Ponte Giulio reserves the right to execute all technical product modification deemed necessary to improve them.

Direzione artistica e grafica

Art direction and graphics

Michela Benaglia, Stefano Monelli

Supervisione al progetto

Project supervision

Paola Staiano - tac.cominc@zione, Stefano Monelli, Adriano Scutigliani

Immagini virtuali

Renders

Filippo Scarso

Foto e post-produzione

Photo and post-production

Foto Studio Mauro Mattioli

Si ringrazia

Special thanks to

Per avere posato nelle immagini di ambiente

To have posed in the environment images

ANGELA, MAURIZIO, MATTEO, MILENA, BEATRICE, MATTEO, ANDREA, PAOLO, CARLOTTA e STEFANO

Per la foto di Orvieto

For the Orvieto landscape image

GIOVANNINO CINQUE

Finito di stampare nel mese di gennaio 2018

Primaprint s.r.l., Viterbo

CLHU.IT/EN.01.18, © 2018 - Ponte Giulio S.p.A.